

Pentatec®

Das universellste Dreh-Bohr-Werkzeug
Kostenreduktion auf allen Hauptwerkstoffen

BOEHLERIT

Member of the LEITZ Group

Pentatec®

The most universal turning-
drilling-tool
Cost reduction on all main
materials



Programmübersicht	Range of tools	2
Dreh-Bohr-Werkzeug	Turning-drilling-tool	3
Weitere Einsatzmöglichkeiten	Additional application possibilities	4
Konstruktionsmerkmale	Features and benefits	5
Technische Hinweise	Technical hints	6
Wendeschneidplatten	Indexable inserts	8
Mini Werkzeug und Adapter	Mini Tool and adapter	9
Sortenübersicht	Grade overview	10
Schnittparameter	Cutting data	11
Bearbeitungsbeispiele	Machining examples	15
Vertriebsgesellschaften	Sales organisations	16



BOEHLERIT Kapfenberg in der Steiermark/Österreich, in Styria/Austria

Technische Änderungen und Druckfehler vorbehalten.
Subject to changes from technical development and printing errors.

1. Plandrehen
1. Face turning



4. Innenlängsdrehen
4. Internal turning

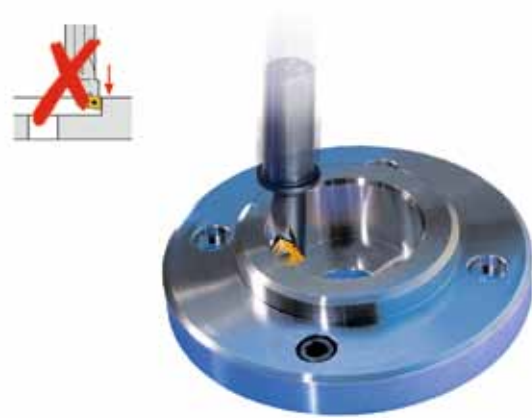

2. Längsdrehen
2. External turning

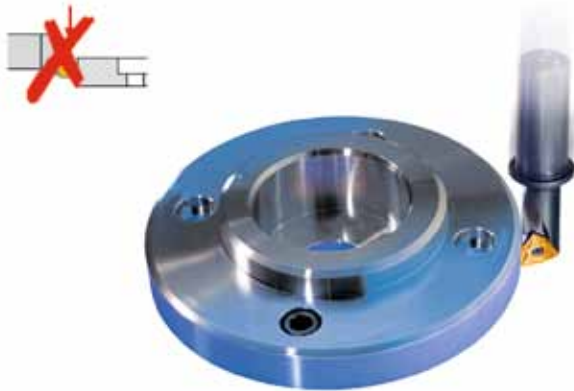

5. Senken (nach DIN 74)
5. Counter Bore Milling (to DIN 74)

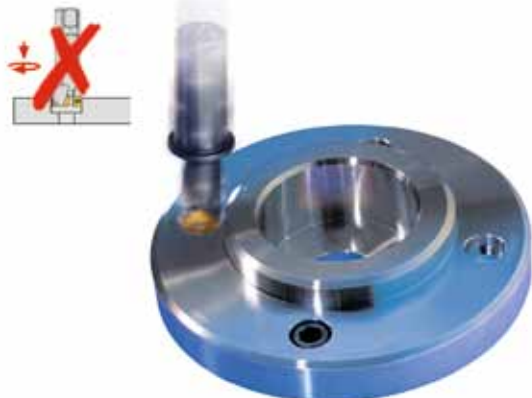

3. Bohren ins Volle mit geradem Bohrgang
3. Drilling into solid with flat drilling base

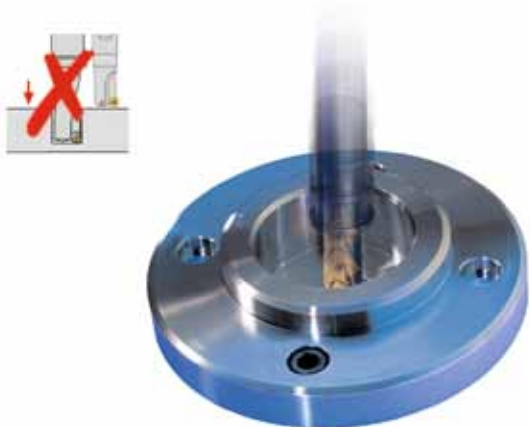

Fünf Bearbeitungsoperationen, ein Werkzeug

Das universelle Dreh-Bohr-Werkzeug ersetzt bis zu fünf ISO-Werkzeuge und reduziert die Bearbeitungszeiten um bis zu 30% durch die Einsparung von Werkzeugwechselzeiten und Werkzeugleerfahrten.

Five machining operations, one tool

The universal turning-drilling-tool substitutes up to 5 ISO-tools and reduces machining times up to 30% through saving of tool changing times and unnecessary tool movements.

Nebenschneide einsetzbar
 Secondary cutting edge can be used

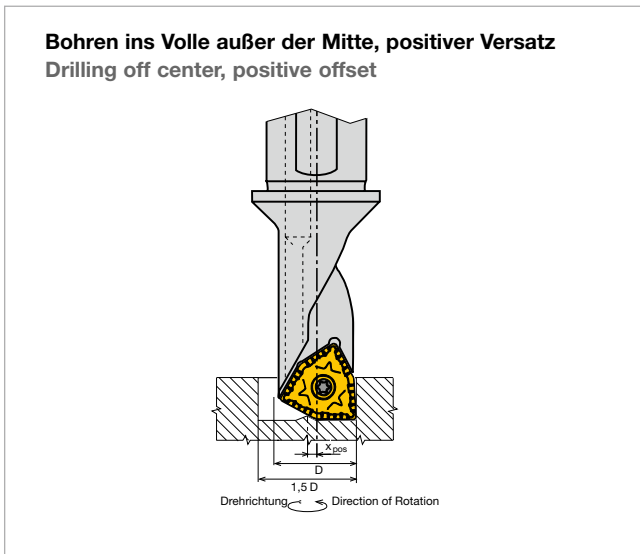

X_{pos} : Versatz aus der Mitte positiv
 Offset, positive

D: Nenndurchmesser Werkzeug
 Nominal tool diameter

Stahl $X_{pos} = \frac{(1,1 \times D) - D}{2}$
 Steel

Aluminium $X_{pos} = \frac{(1,5 \times D) - D}{2}$
 Aluminium

Werkzeug 2,25D/1,50D Tool	D	Stahl Steel		Aluminium Aluminium	
		D_{max}	x_{pos}	D_{max}	x_{pos}
PTR/L 08 -x,xxD- 04	8H13	8,8	0,40	12,0	2,00
PTR/L 10 -x,xxD- 05	10H13	11,0	0,50	15,0	2,50
PTR/L 11 -x,xxD- 06	11H13	12,1	0,55	16,5	2,75
PTR/L 15 -x,xxD- 07	15H13	16,5	0,75	22,5	3,75
PTR/L 18 -x,xxD- 09	18H13	19,8	0,90	27,0	4,50
PTR/L 20 -x,xxD- 10	20H13	22,0	1,00	30,0	5,00
PTR/L 26 -x,xxD- 13	26H13	28,6	1,30	39,0	6,50

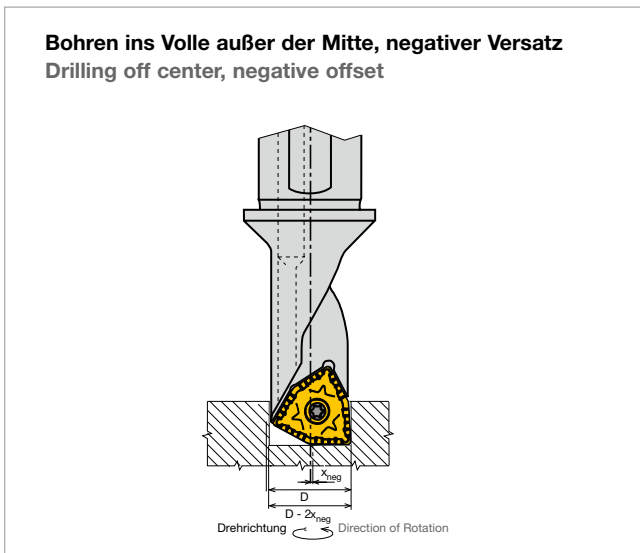

X_{neg} : Versatz aus der Mitte negativ
 Offset, negative

D: Nenndurchmesser Werkzeug
 Nominal tool diameter

$$X_{neg} = \frac{D_{min} - D}{2}$$

Werkzeug 2,25D/1,50D Tool	D	D_{min}	x_{neg}
PTR/L 08 -x,xxD- 04	08H13	7,8	0,10
PTR/L 10 -x,xxD- 05	10H13	9,8	0,10
PTR/L 11 -x,xxD- 06	11H13	10,8	0,10
PTR/L 15 -x,xxD- 07	15H13	14,7	0,15
PTR/L 18 -x,xxD- 09	18H13	17,7	0,15
PTR/L 20 -x,xxD- 10	20H13	19,7	0,15
PTR/L 26 -x,xxD- 13	26H13	25,7	0,15

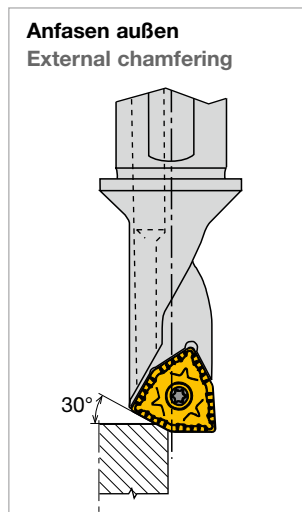
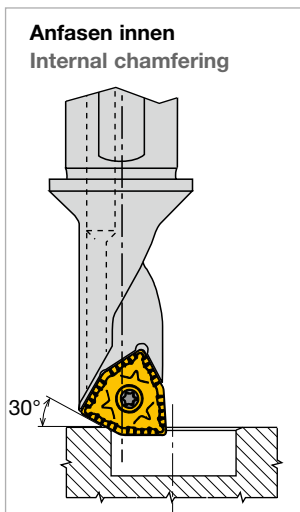

Senkbohrung mit Pentatec®-Werkzeugen
Core drilling with Pentatec®-tools

Die Durchmesserreihe der Pentatec®-Werkzeuge ist so ausgelegt, dass damit Senkbohrungen nach DIN 74 Form H3, J3 und K3 in einem Arbeitsgang produziert werden können.

The diameters of the Pentatec®-tools are designed to produce counter-bores according to DIN 74 forms H3, J3 and K3 in one operation.

- Form H3 für: Zylinderschrauben nach DIN 84 und DIN 7984
 Gewindefurchende Schrauben nach DIN 7513 Form B
 Gewindefurchende Schrauben nach DIN 7500 Teil1 Form A
- Form J3 für: Zylinderschrauben nach DIN 6912
 (niedriger Kopf, Schlüsselführung)
- Form K3 für: Zylinderschrauben nach DIN 912

Mit Federring nach DIN 7980

- Form H3 for: cheese-head screws according to DIN 84
 socket head cap screws to DIN 7984
 cheese-head screws according to DIN 7513 form B
 cheese-head screws according to DIN 7500 part 1 form A
- Form J3 for: socket head cap screws according to DIN 6912
 (low screw head, key guide)
- Form K3 for: socket head cap screws according to DIN 912

with lock washer according to DIN 7980

Werkzeug 2,25D/1,50D Tool	Gewinde Thread Nenn Durchmesser nominal diameter	D	H13
PTR/L 08 -x,xxD- 04	M 4	8	0/+0,220
PTR/L 10 -x,xxD- 05	M 5	10	0/+0,220
PTR/L 11 -x,xxD- 06	M 6	11	0/+0,270
PTR/L 15 -x,xxD- 07	M 8	15	0/+0,270
PTR/L 18 -x,xxD- 09	M 10	18	0/+0,330
PTR/L 20 -x,xxD- 10	M 12	20	0/+0,330
PTR/L 26 -x,xxD- 13	M 16	26	0/+0,330

Große Aufnahmedurchmesser und Plananlage
Large mounting diameter and location face

	Pentatec®		ISO-Bohrstange ISO-boring bar
	PTR20-2,25D	PTR20-1,50D	
D _{min}	20	20	21
d Aufnahme d shank	25/32* * Durchmesser am Bund * Diameter at the flange	25	16
Plananlage Seating face	Ja Yes	Nein No	Nein No

Pentatec®-Nutzen:

Höhere Stabilität und geringere Vibrationsneigung durch größere Aufnahmedurchmesser und zusätzliche Plananlage bei PT-2,25D

Pentatec®-benefits:

More stability and less tendency to vibrate through larger locating diameters and the additional seating face for PT-2,25D

Bezeichnungssystem Pentatec®
Designation system Pentatec®

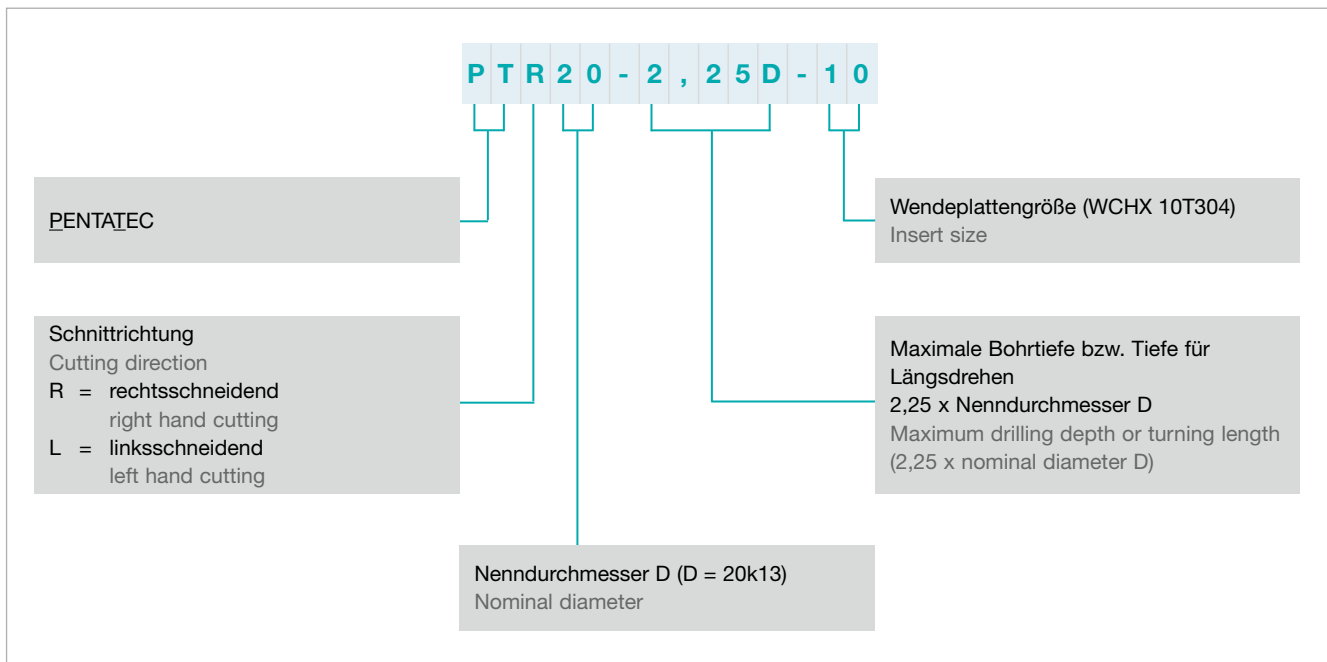

LMT-Schneidstoffsorten, Bezeichnung
LMT Cutting materials, designation system

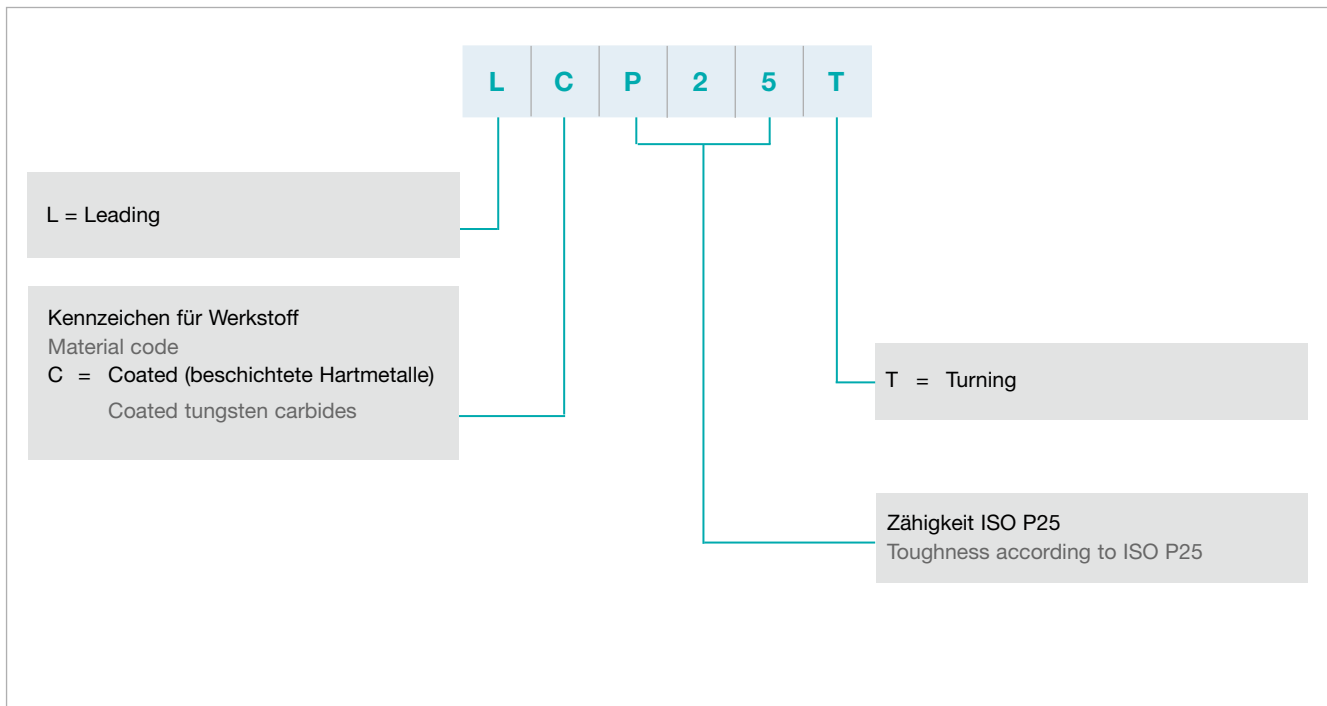

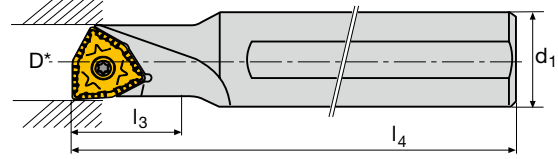
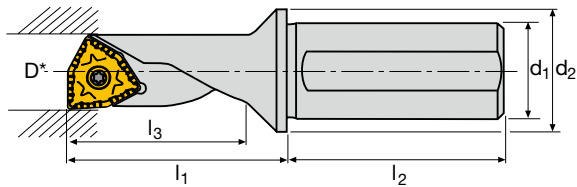

D* = Durchmesser für Senkbohrung laut DIN 74
Diameter for plunge drilling according to DIN 74





Bestellbezeichnung Ordering Code	D*	d ₁	d ₂	l ₁	l ₂	l ₃	l ₄	Passende Wendeplatte Indexable insert
PTR/L 08 - 2,25D-04	8	10	12	22,5	38	18,0	-	WCHX 04....
PTR/L 08 - 1,50D-04	8	12	-	-	-	12,0	80	
PTR/L 10 - 2,25D-05	10	12	16	28	42	22,5	-	WCHX 05....
PTR/L 10 - 1,50D-05	10	12	-	-	-	15,0	90	
PTR/L 11 - 2,25D-06	11	16	20	32	45	24,75	-	WCHX 06....
PTR/L 11 - 1,50D-06	11	16	-	-	-	16,5	100	
PTR/L 15 - 2,25D-07	15	20	25	43	50	33,75	-	WCHX 07....
PTR/L 15 - 1,50D-07	15	20	-	-	-	22,5	125	
PTR/L 18 - 2,25D-09	18	25	32	53	56	40,5	-	WCHX 09....
PTR/L 18 - 1,50D-09	18	25	-	-	-	27,0	135	
PTR/L 20 - 2,25D-10	20	25	32	56	56	45,0	-	WCHX 10....
PTR/L 20 - 1,50D-10	20	25	-	-	-	30,0	150	
PTR/L 26 - 2,25D-13	26	32	40	73	60	58,5	-	WCHX 13....
PTR/L 26 - 1,50D-13	26	32	-	-	-	39,0	180	

Bestellbeispiel: 1 Stück PTR15-2,25D-07
Ordering example: 1 off PTR15-2,25D-07

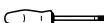
Auf Anfrage bieten wir Pentatec® Werkzeuge mit schwingungsdämpfenden Densimet (Schwermetall) an.
On request we offer Pentatec® tools with vibrations damping Densimet (heavy duty metal).

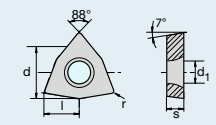
Ersatzteile Spare parts

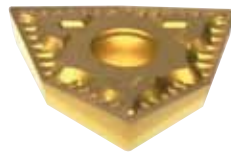
Ersatzteile Spare parts	Bestellbezeichnung Ordering Code		Torx	Anzugsmoment Torque [Ncm]
	 Schraube Screw	 Schlüssel Key		
PTR/L 08	A02-20033	V04-T0600	06	62
PTR/L 10	A13-25042	V04-T0800	08	128
PTR/L 11	A13-25050	V04T-0800	08	128
PTR/L 15	A13-30073	V04T-0800	08	180
PTR/L 18	A02-35082	V04-T1500	15	345
PTR/L 20	A06-50088	V04-T2000	20	1020
PTR/L 26	A02-60120	V04T-2500	25	1750
PTR/L 33	A02-60160	V04-T2500	25	1750

	Bestellbezeichnung Ordering code	l	d	s	d ₁	r	Schneidstoff Grade		
							LCP25T	LCM45T	LW610
WCHX...-BAL 	WCHX 040102 FN-BAL	4,0	6,35	1,59	2,25	0,2			●
	WCHX 040104 FN-BAL	4,0	6,35	1,59	2,25	0,4			●
	WCHX 05T102 FN-BAL	5,0	7,938	1,98	2,8	0,2			●
	WCHX 05T104 FN-BAL	5,0	7,938	1,98	2,8	0,4			●
	WCHX 060202 FN-BAL	5,5	8,73	2,38	2,8	0,2			●
	WCHX 060204 FN-BAL	5,5	8,73	2,38	2,8	0,4			●
	WCHX 070304 FN-BAL	7,5	12,0	3,18	3,4	0,4			●
	WCHX 070308 FN-BAL	7,5	12,0	3,18	3,4	0,8			●
	WCHX 090304 FN-BAL	9,0	14,29	3,18	4,4	0,4			●
	WCHX 090308 FN-BAL	9,0	14,29	3,18	4,4	0,8			●
	WCHX 10T304 FN-BAL	10,0	15,875	3,97	5,9	0,4			●
	WCHX 10T308 FN-BAL	10,0	15,875	3,97	5,9	0,8			●
	WCHX 130508 FN-BAL	13,0	21,0	5,56	7,0	0,8			●
WCHX...-BFM 	WCHX 040102 EN-BFM	4,0	6,35	1,59	2,25	0,2	●		
	WCHX 040104 EN-BFM	4,0	6,35	1,59	2,25	0,4	●		
	WCHX 05T102 EN-BFM	5,0	7,938	1,98	2,8	0,2	●		
	WCHX 05T104 EN-BFM	5,0	7,938	1,98	2,8	0,4	●		
	WCHX 060202 EN-BFM	5,5	8,73	2,38	2,8	0,2	●		
	WCHX 060204 EN-BFM	5,5	8,73	2,38	2,8	0,4	●		
	WCHX 070304 EN-BFM	7,5	12,0	3,18	3,4	0,4	●		
	WCHX 070308 EN-BFM	7,5	12,0	3,18	3,4	0,8	●		
	WCHX 090304 EN-BFM	9,0	14,29	3,18	4,4	0,4	●		
	WCHX 090308 EN-BFM	9,0	14,29	3,18	4,4	0,8	●		
	WCHX 10T304 EN-BFM	10,0	15,875	3,97	5,9	0,4	●		
	WCHX 10T308 EN-BFM	10,0	15,875	3,97	5,9	0,8	●		
	WCHX 130508 EN-BFM	13,0	21,0	5,56	7,0	0,8	●		
WCHX...-BFM 	WCHX 040102 EN-BFM	4,0	6,35	1,59	2,25	0,2		●	
	WCHX 040104 EN-BFM	4,0	6,35	1,59	2,25	0,4		●	
	WCHX 05T102 EN-BFM	5,0	7,938	1,98	2,8	0,2		●	
	WCHX 05T104 EN-BFM	5,0	7,938	1,98	2,8	0,4		●	
	WCHX 060202 EN-BFM	5,5	8,73	2,38	2,8	0,2		●	
	WCHX 060204 EN-BFM	5,5	8,73	2,38	2,8	0,4		●	
	WCHX 070304 EN-BFM	7,5	12,0	3,18	3,4	0,4		●	
	WCHX 070308 EN-BFM	7,5	12,0	3,18	3,4	0,8		●	
	WCHX 090304 EN-BFM	9,0	14,29	3,18	4,4	0,4		●	
	WCHX 090308 EN-BFM	9,0	14,29	3,18	4,4	0,8		●	
	WCHX 10T304 EN-BFM	10,0	15,875	3,97	5,9	0,4		●	
	WCHX 10T308 EN-BFM	10,0	15,875	3,97	5,9	0,8		●	
	WCHX 130508 EN-BFM	13,0	21,0	5,56	7,0	0,8		●	

● : Verfügbar ab Lager Available from stock

Bestellbeispiel: 1 Stück WCHX 10T308EN-BFM LC444W

Ordering example: 1 piece WCHX 10T308EN-BFM LC444W

Pentatec® - Mini

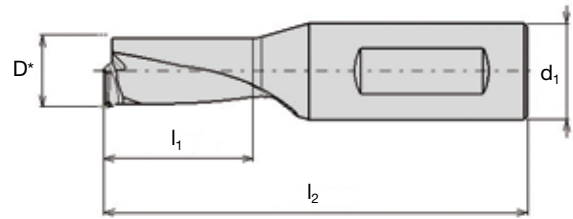

D* = Durchmesser für Senkbohrung laut DIN 74
 Diameter for plunge drilling according to DIN 74

Bestellbezeichnung Ordering Code	D*	d ₁	l ₁	l ₂	LC630T
PTR/L 06 - 2,25D	6	8	13,5	38	●

Bestellbeispiel: 1 Stück PTL06-2,25D LC 630T
 Ordering example: 1 piece PTL06-2,25D LC 630T

Pentatec® - Adapter

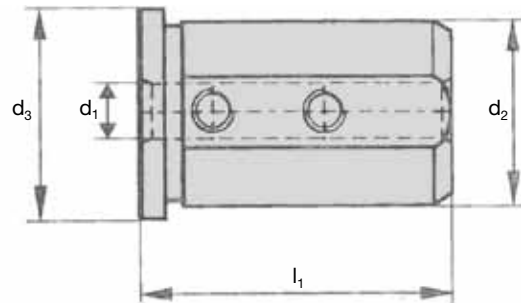

D* = Durchmesser für Senkbohrung laut DIN 74
 Diameter for plunge drilling according to DIN 74

Bestellbezeichnung Ordering Code	d ₁	d ₂	d ₃	l ₁
PTA 25-08	8	25	29	50

Bestellbeispiel: 1 Stück PTA 25-08
 Ordering example: 1 piece PTA 25-08

Sorte Grade	ISO	Anwendungsbereich Application range	Werkstoffgruppe Material group						Bearbeitungsverfahren Application					
			P	M	K	N	S	H	T	M	D	S	G	P
		01 05 10 15 20 25 30 35 40 45 50	Stahl Steel	Rostfrei Stainless	Grauguss Grey cast iron	NE-Metalle Al, Mg, Ti, Zr Nonferrous metals	Hochwarmfest High temper- ature materials	Harte Werkstoffe Hard materials	Drehen Turning	Fräsen Milling	Bohren Drilling	Gewinde- bearbeitung Threading	Einstechen Grooving	Abstechen Parting
LCP25T	HC-P25		■						●		●			
	HC-M25			□					●		●			
LC444W	HC-M40			□					●		●			
	HC-P35		■						●		●			
LW610	HW-K10					■			●		●			
Anwendungsschwerpunkt Application peak Gesamtbereich nach ISO 513 Full range to ISO 513			■ Hauptanwendung Main application □ Weitere Anwendung Further applications						● Standardsorte Standard grade					

1) Nur Pentatec®-Mini
Only Pentatec®-mini

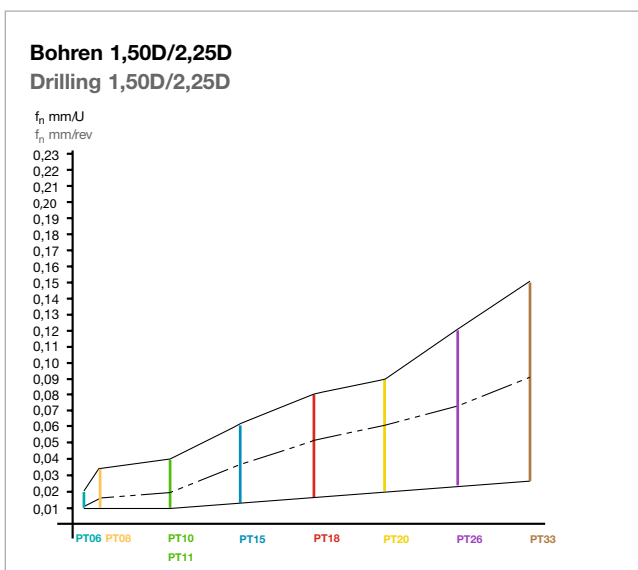
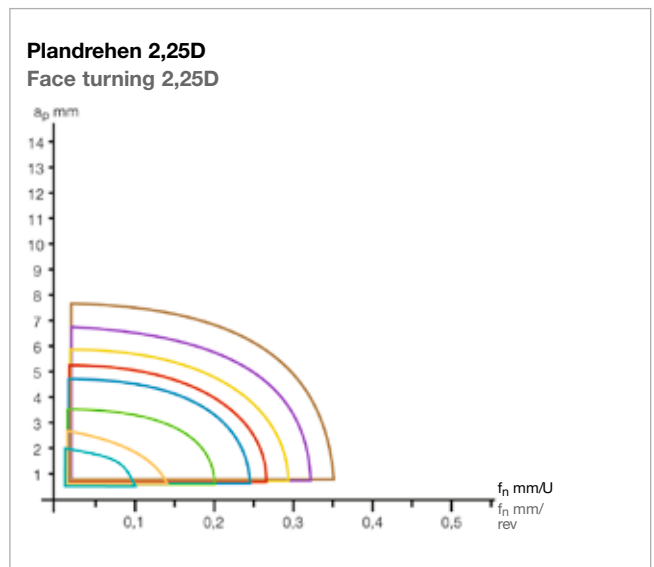
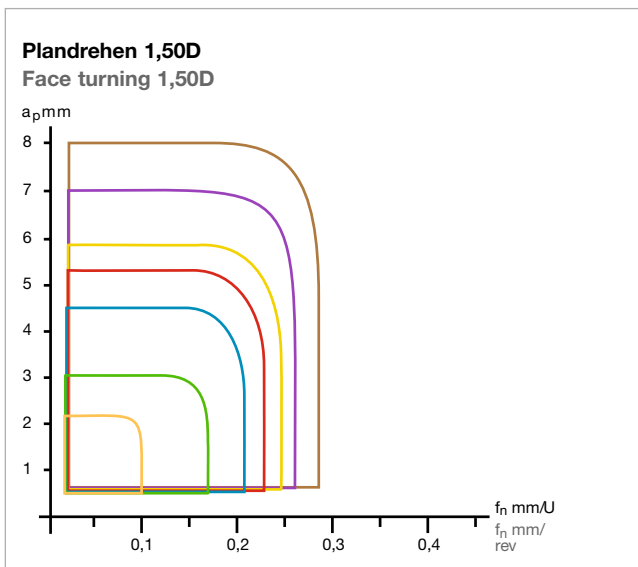
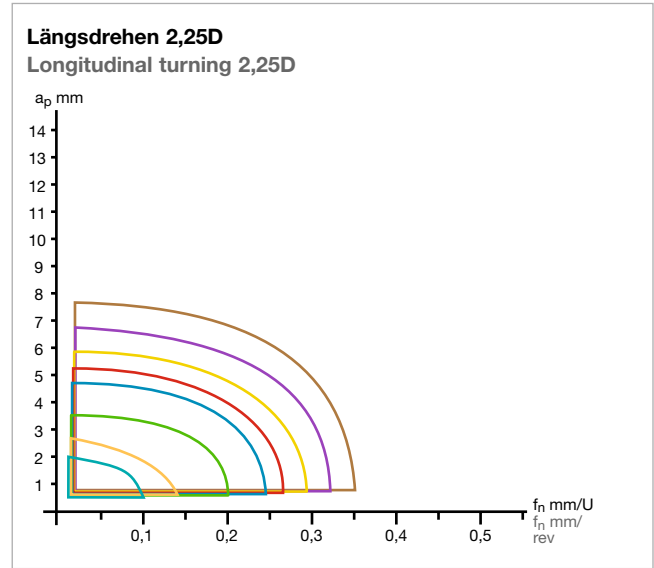
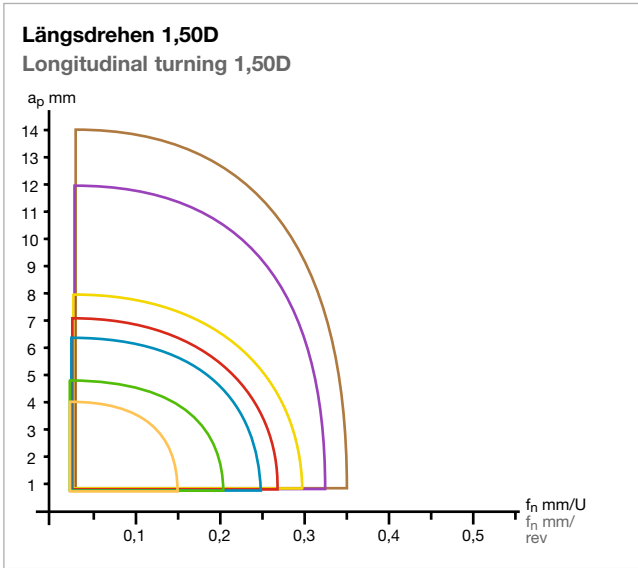

- = PT33
- = PT26
- = PT20
- = PT18
- = PT15
- = PT11
- = PT10
- = PT08
- = PT06 ¹⁾

Verwenden Sie beim Bohren die zähe Sorte LC444W.
 Please use for drilling the tough grade LC444W.

¹⁾ Für Stahl, Rostfrei und Grauguss For steel, stainless steel and grey cast iron

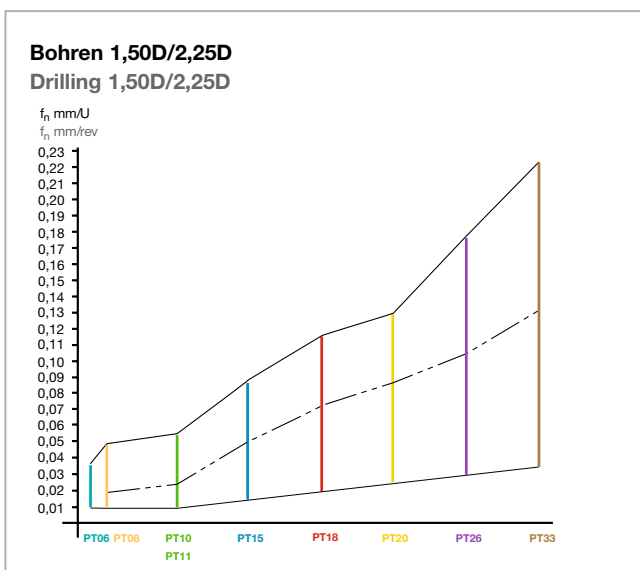
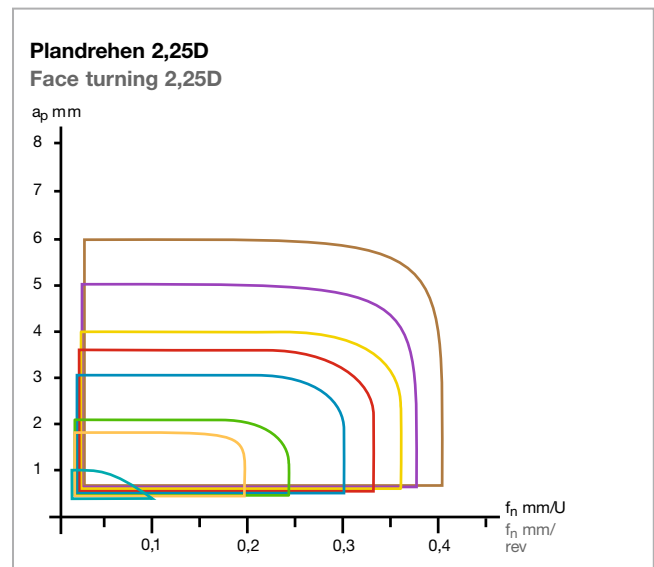
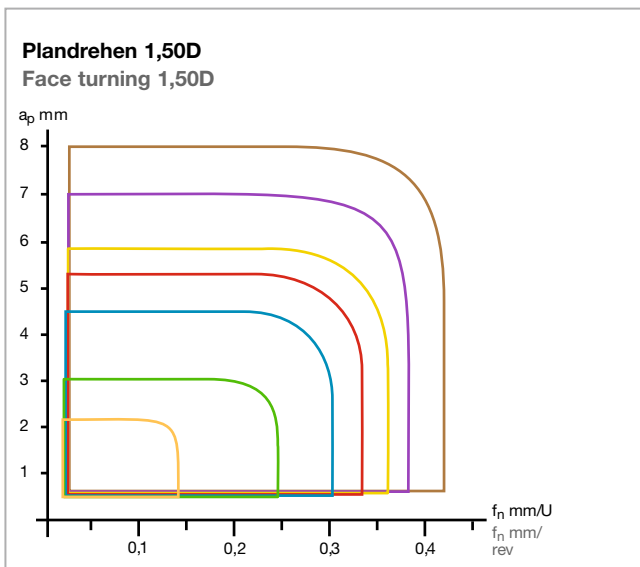
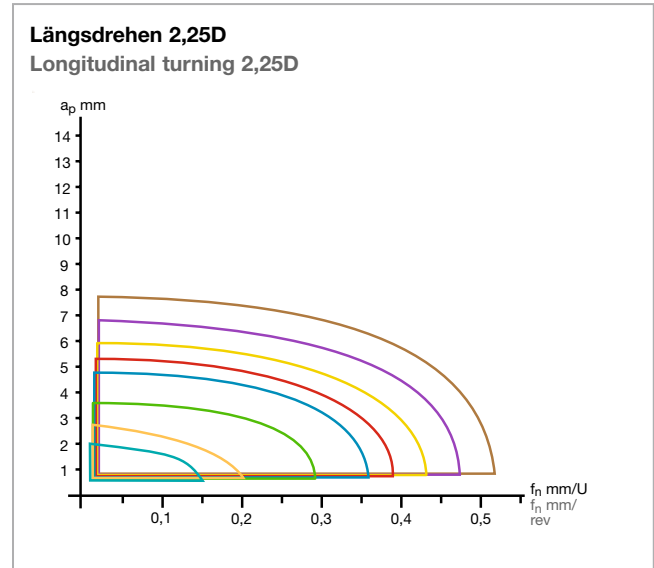
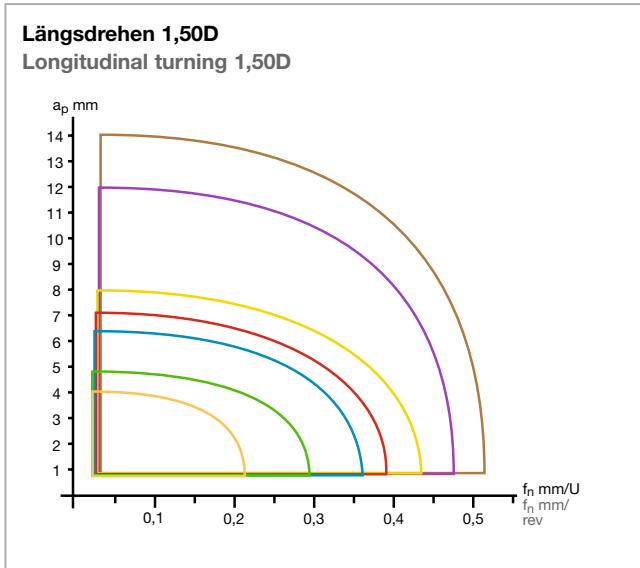

- = PT33
- = PT26
- = PT20
- = PT18
- = PT15
- = PT11
- = PT10
- = PT08

	Gliederung der Werkstoff-Hauptgruppen und Kennbuchstaben		Brinell Härte HB	Drehen und Bohren v _c m/min				
				LCP25T	LC444W	LW610		
P	Unlegierter Stahl ¹⁾	ca 0,15%C	geglüht	125	170 - 300	120 - 250		
		ca 0,45%C	geglüht	190	150 - 255	100 - 200		
		ca 0,45%C	vergütet	250	100 - 200	70 - 180		
		ca 0,75%C	geglüht	270	110 - 185	70 - 180		
		ca 0,75%C	vergütet	300	90 - 160	50 - 150		
	Niedrig legierter Stahl ¹⁾	geglüht		180	120 - 240	80 - 200		
		vergütet		275	100 - 210	70 - 180		
		vergütet		300	100 - 185	100 - 185		
		vergütet		350	90 - 145	70 - 150		
	Hochlegierter Stahl und hochleg. Werkzeugstahl	geglüht		200	130 - 215	70 - 180		
gehärtet und angelassen			325	80 - 140	50 - 120			
Nichtrostender Stahl ¹⁾	ferritisch / martensitisch	geglüht	200	110 - 200	70 - 150			
		martensitisch vergütet	240	100 - 160	70 - 120			
M	Nichtrostender Stahl ¹⁾	austenitisch ²⁾ , abgeschreckt	180	90 - 160	50 - 150			
K	Grauguss	perlitisches / ferritisches	180			150 - 250		
		perlitisches (martensitisches)	260			100 - 150		
	Gusseisen mit Kugelgraphit	ferritisches	160			130 - 80		
		perlitisches	250			100 - 150		
	Temperguss	ferritisches	130			120 - 180		
		perlitisches	230			100 - 160		
N	Aluminium-Knetlegierungen	nicht aushärtbar	60			400 - 2400		
		aushärtbar, ausgehärtet	100			160 - 1600		
	Aluminium-Gusslegierungen	≤ 12% Si. nicht aushärtbar	75			320 - 1200		
		≤ 12% Si. aushärtbar, ausgehärtet	90			240 - 950		
		> 12% Si. nicht aushärtbar	130			160 - 800		
	Kupfer und Kupferlegierungen (Bronze / Messing)	Automatenlegierung Pb>1%	110			200 - 520		
		Messing, Rotguß	90			200 - 800		
		Bronze, bleifreies Kupfer und Elektrolytkupfer	100			120 - 320		
	Nichtmetallische Werkstoffe	Duroplaste						
		Faserverstärkte Kunststoffe						
Hartgummi								
S	Warmfeste Legierungen	Fe-Basis	geglüht	200				
			ausgehärtet	280				
		Ni- oder Co-Basis	geglüht	250				
			ausgehärtet	350				
			gegossen	320				
		Titanlegierungen	Reintitan	Rm ³⁾ 400				
Alpha + Beta- Legierungen, ausgehärtet	Rm ³⁾ 1050							

1) und Stahlguss

2) und austenitische / ferritische

3) Rm = Zugfestigkeit in N/mm²

4) HRC = Rockwellhärte C

Material group	Main workpiece material groups and their characteristic letters Workpiece material		Brinell hardness HB	Turning and Drilling v _c m/min		
				LCP25T	LC444W	LW610
P	Unalloyed steel ¹⁾	≈0,15%C annealed	125	170 - 300	120 - 250	
		≈0,45%C annealed	190	150 - 255	100 - 200	
		≈0,45%C hardened and temp	250	100 - 200	70 - 180	
		≈0,75%C annealed	270	110 - 185	70 - 180	
		≈0,75%C hardened and temp	300	90 - 160	50 - 150	
	Low-alloy steel ¹⁾	annealed	180	120 - 240	80 - 200	
		hardened and temp.	275	100 - 210	70 - 180	
		hardened and temp.	300	100 - 185	100 - 185	
		hardened and temp.	350	90 - 145	70 - 150	
	High-alloy steel and high-alloy tool steel ¹⁾	annealed	200	130 - 215	70 - 180	
hardened and temp.		325	80 - 140	50 - 120		
Stainless steel ¹⁾	ferritic / martensitic annealed	200	110 - 200	70 - 150		
	martensitic hardened and temp.	240	100 - 160	70 - 120		
M	Stainless steel ¹⁾	austenitic ²⁾ , quenched	180	90 - 160	50 - 150	
K	Grey cast iron	perlitic / ferritic	180		150 - 250	
		perlitic (martensitic)	260		100 - 150	
	Nodular graphite cast iron	ferritic	160		130 - 80	
		perlitic	250		100 - 150	
	Malleable cast iron	ferritic	130		120 - 180	
perlitic		230		100 - 160		
N	Aluminium wrought alloys	unhardenable	60		400 - 2400	
		hardenable, hardened	100		160 - 1600	
	Aluminium cast alloys	≤ 12% Si. unhardenable	75		320 - 1200	
		≤ 12% Si. hardenable, hardened	90		240 - 950	
		> 12% Si. unhardenable	130		160 - 800	
	Copper and copper alloys (Bronze / Brass)	Free cutting alloys Pb>1%	110		200 - 520	
		Brass, Red bronze	90		200 - 800	
		Bronze, non leaded copper and electrolytic copper	100		120 - 320	
	Nonmetallic materials	Duroplastics				
		Fibre reinforced plastics				
Hard rubber						
S	Heat resistant alloys	Fe-based annealed	200			
			hardened	280		
		Ni- or Co-based annealed	250			
			hardened	350		
	Titanium alloys	Pure titanium	Rm ³⁾ 400			
		Alpha- and Beta-alloys hardened	Rm ³⁾ 1050			

1) and cast steel

2) and austenitic / ferritic

3) Rm = tensile strength in N/mm²

4) HRC = Rockwell hardness C

<p>Mutter/ St52 Nut</p> 	<p>Werkzeug: Tool: Pentatec® PTL15-1,50D-07</p> <p>Wendepatte/Sorte: Insert / Grade: WCHX 070304EN-BFM / LCP25T</p> <p>Anwendungen: Applications: Bohren Drilling Längsdrehen Longitudinal turning</p> <p>Kühlung: Coolant: Emulsion Emulsion</p> <p>Schnittparameter: Cutting data: v_c 150 m/min 180 m/min a_p 1 mm f 0,07 mm/U rev 0,2 mm/U rev</p> <p>Ergebnis: Result: Reduzierung der Stückzeit um 30 % Ersatz von drei Werkzeugen Reduction of machining time by 30 % Three Tools replaced</p>
<p>Flansch / Aluminium Flange / Aluminium</p> 	<p>Werkzeug: Tool: Pentatec® PTR20-1,50D-10</p> <p>Wendepatte/Sorte: Insert / Grade: WCHX 10T308FN-BAL / LW610</p> <p>Anwendungen: Applications: Plandrehen Face turning Bohren Drilling</p> <p>Kühlung: Coolant: nass wet</p> <p>Schnittparameter: Cutting data: v_c 300 m/min 300 m/min a_p 2 mm f 0,15 mm/U rev 0,30 mm/U rev</p> <p>Ergebnis: Result: Reduzierung der Bearbeitungszeit um 50 %. Reduction of machining time by 50 %</p>
<p>Buchse / St52 (SAE 1055) Bush</p> 	<p>Werkzeug: Tool: Pentatec® PTL20-1,50D-10</p> <p>Wendepatte/Sorte: Insert / Grade: WCHX 10T304EN-BFM / LCP25T</p> <p>Anwendungen: Applications: Bohren Drilling Ausdrehen Boring</p> <p>Kühlung: Coolant: Emulsion Emulsion</p> <p>Schnittparameter: Cutting data: v_c 200 m/min 200 m/min a_p 1,5 mm f 0,03-0,05 mm/U rev 0,15 mm/U rev</p> <p>Ergebnis: Result: 25 % kürzere Bearbeitungszeit .Ersatz eines Werk- zeuges. Einsparung eines Werkzeugwechselplatzes Reduction of machining time by 25 %. One tool replaced. One tool place saved.</p>
<p>Schmiedeteil / St37 (SAE 1035) Forged piece</p> 	<p>Werkzeug: Tool: Pentatec® PTR20-1,50D-10</p> <p>Wendepatte/Sorte: Insert / Grade: WCHX 10T304EN-BFM / LCP25T</p> <p>Anwendungen: Applications: Plandrehen, Bohren Face turning, drilling Ausdrehen Boring</p> <p>Kühlung: Cooling: Emulsion Emulsion</p> <p>Schnittparameter: Cutting data: v_c 180 m/min 180 m/min a_p 1 mm 2 mm f 0,06 mm/U rev 0,15 mm/U rev</p> <p>Ergebnis: Result: 25 % kürzere Bearbeitungszeit. Einsparung eines Bohrwerkzeuges Reduction of machining time by 25 %. One drilling tool saved.</p>

BOEHLERIT

BOEHLERIT GmbH & Co. KG

Werk VI-Strasse
8605 Kapfenberg
Österreich/Austria
Telefon +43 3862 300 - 0
Telefax +43 3862 300 - 793
info@boehlerit.com
www.boehlerit.com

Brasilien/Brazil

LMT Boehlerit Ltda.
Rua André de Leão 155
Bloco A CEP: 04762-030
Socorro-Santo Amaro
São Paulo
Telefon +55 11 55460755
Telefax +55 11 55460476
lmt.br@lmt-tools.com
www.lmt-tools.com

China

LMT China Co. Ltd.
No. 8 Phoenix Road,
Jiangning Development Zone
211100 Nanjing
Telefon +86 25 52103111
Telefax +86 25 52106376
lmt.cn@lmt-tools.com
www.lmt-tools.com

Deutschland/Germany

LMT Tool Systems GmbH
Heidenheimer Straße 84
D-73447 Oberkochen
Telefon +49 7364 9579-0
Telefax +49 7364 9579-8000
lmt.de@lmt-tools.com
www.lmt-tools.com

England/United Kingdom

LMT UK Ltd
5 Elm Court
Meriden Business Park
Copse Drive
Meriden CV5 9RG
Telefon. +44 16 76 523440
Telefax. +44 16 76 525379
lmt.uk@lmt-tools.com

Frankreich/France

LMT France
Lieu dit «Les Cizes»
F-01590 LAVANCIA
Telefon +33 4 74 75 46 89
Telefax +33 4 74 75 89 90
info@lmt-belin.com

Indien/India

LMT Fette (India) Pvt Ltd
29 (Old No. 14) II Main Road
Gandhinagar, Adyar
Chennai 600 020, India
Telefon +91 44 24405136
Telefax +91 44 24405205
lmt.in@lmt-tools.com

Italien/Italy

LMT Italy S.r.l.
Via Buozzi 31
I-20090 Segrate (MI)
Telefon +39 02 2694971
Telefax +39 02 21872456
lmt.it@lmt-italy.it

Mexiko/Mexico

LMT Boehlerit S.A. de C.V.
Av. Acueducto No. 15
Parque Industrial Bernardo
Quintana
El Marqués, Querétaro
México. C.P. 76246
Telefon +52 442 2215706
Telefax +52 442 2215555
lmt.mx@lmt-tools.com
www.lmt-tools.com

Polen/Poland

LMT Boehlerit Polska
Ul. Wysogotowska 9
PL 62-081 Przeźmierowo
Telefon +48 61 6512030
Telefax +48 61 6232014
lmt.pl@lmt-tools.com
www.lmt-tools.com

Russische Föderation/ Russian Federation

LMT Russia
Kotlyakovskaya str. 3, bld.1
115201, Moscow,
Telefon +7 495 510 10 27
Telefax +7 495 510 10 28
info@lmt-russia.ru
www.lmt-russia.ru

Singapur/Singapore

LMT Asia Pte Ltd
1 Clementi Loop 04-04
Clementi West District Park
Singapore 12 98 08
Telefon +65 64 624214
Telefax +65 64 624215
lmt.sg@lmt-tools.com

Spanien/Spain

LMT Boehlerit S.L.
C/. Narcis Monturiol 11-15
E-08339 Vilassar de Dalt
Barcelona
Telefon +34 93 7507907
Telefax +34 93 7507925
lmt.es@lmt-tools.com

Südkorea/South Korea

LMT Korea Co., Ltd
Room # 1520,
Anyang Trade Center
Bisan-Dong, Dongan-Gu
Anyang-Si, Gyeonggi-Do,
431-817, South Korea
Telefon +82 31 3848600
Telefax +82 31 3842121
lmt.kr@lmt-tools.com

Tschechien/Czech Republic

Kancelář Boehlerit
Santražiny 753, CR-760 01 ZLÍN
Telefon +420 577 214989
Telefax +420 577 219061
boehlerit@boehlerit.cz
boehlerit@boehlerit.sk
www.boehlerit.cz
www.boehlerit.sk

Türkei/Turkey

Böhler Sert Maden ve
Takım Sanayi ve
Ticaret A.S.
Ankara Asfaltı Üzeri, No:22
Kartal 34873 Istanbul
Telefon +90 216 3066570
Telefax +90 216 3066574
lmt.tr@lmt-tools.com
www.lmt-tools.com

Ungarn/Hungary

LMT Böhlerit Kft.
PO Box: 2036 Érdliget Pf. 32
H-2030-Érd, Kis-Duna u.6.
Telefon +36 23 521910
Telefax +36 23 521919
lmt.hu@lmt-tools.com

USA

Kanada/Canada
LMT USA Inc.
1997 Ohio Street
Lisle, Illinois, 60532
Telefon +1 630 9695412
Telefax +1 630 9695492
lmt.us@lmt-tools.com
www.lmt-tools.com